

PRESSURE REDUCING VALVE

EUROBRASS 143 FF



- Direct acting brass pressure reducing valve;
- PN 25;
- Adjustable outlet pressure between 0,5 and 6 bar;
- Brass diaphragm mechanism;
- Pressure compensation system;
- Female threading;
- Max temperature of use 80° C;

FIELDS:

The pressure reducing valves series EUROBRASS 143 are suitable for reduction and control of pressure in plants with the following characteristics:

Max inlet pressure:	25 bar
Field of action (outlet pressure):	0,5 - 6 bar
Max temperature of use:	80° C
Threading of connection:	ISO 228/1
Tested according to rules:	DIN EN 1567
Suitable fluids:	Water, compressed air
Reduction rate :	10 : 1

MATERIALS:

Metal of the body:	Brass alloy CW617N UNI EN 12165 - CB753S EN 1984
Metal of the inner parts:	Brass alloy CW614N UNI EN 12164
Seat:	Stainless steel AISI 303
Bar:	Brass alloy CW614N UNI EN 12164 Stainless steel AISI 303
O-rings:	NBR 70sh
Flat gaskets:	Fasit Italy
Plastic parts:	Ultradid® A3K (BASF)

MAIN DIMENSIONS OF THE PRESSURE REDUCING VALVES EUROBRASS 143

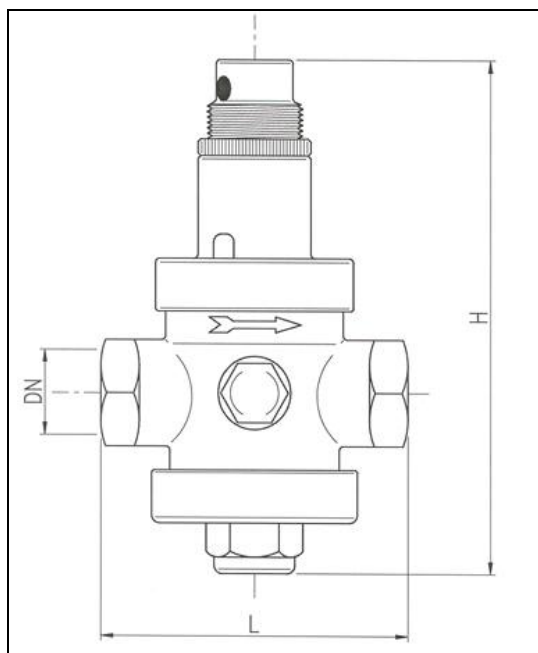

ITEM	DN	Weight gr	H	L
143.38	3/8"	800	120	75
143.12	1/2"	790	120	75
143.34	3/4"	1.130	150	85
143.33	1"	1.340	160	89
143.114	1" 1/4	2.290	220	125
143.112	1" 1/2	2.400	220	130
143.58	2"	3.950	250	138
143.160	2" 1/2	4.100	260	145
143.80	3"	5.520	285	177
143.100	4"	6.970	310	190

FLOW RATE vs PRESSURE DROP CHART:

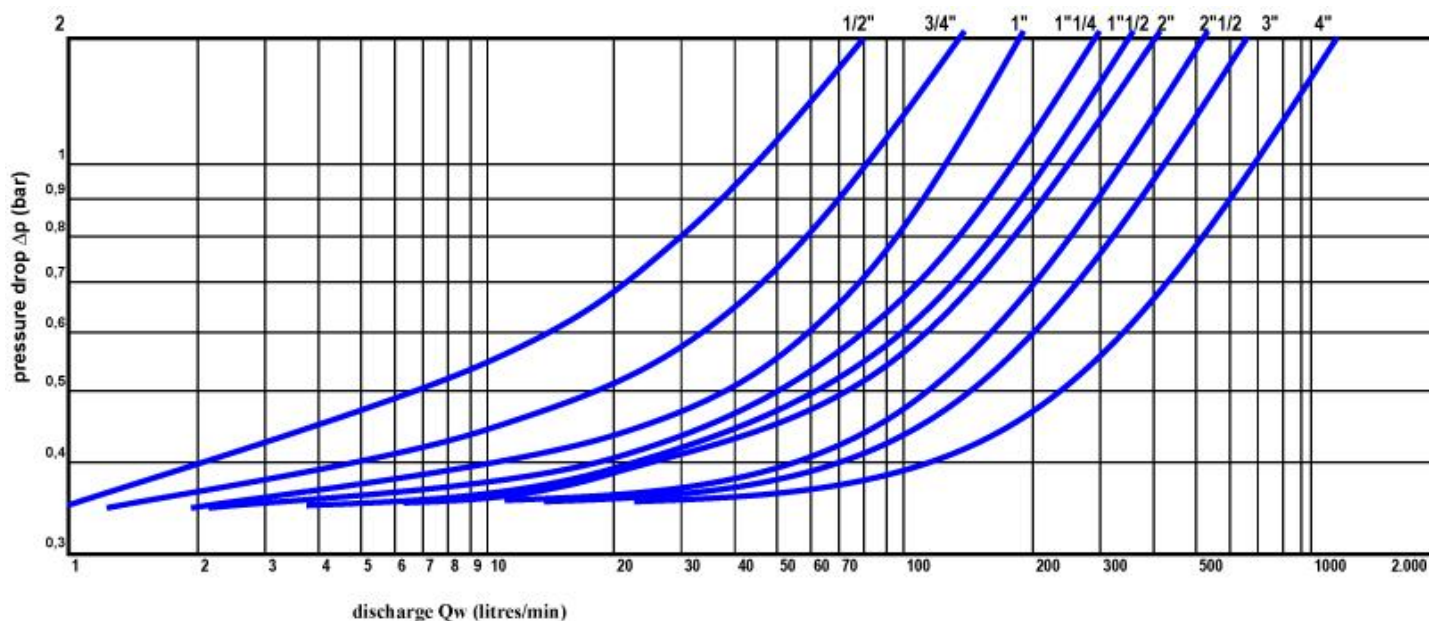

FLOW vs FLOW CHART:

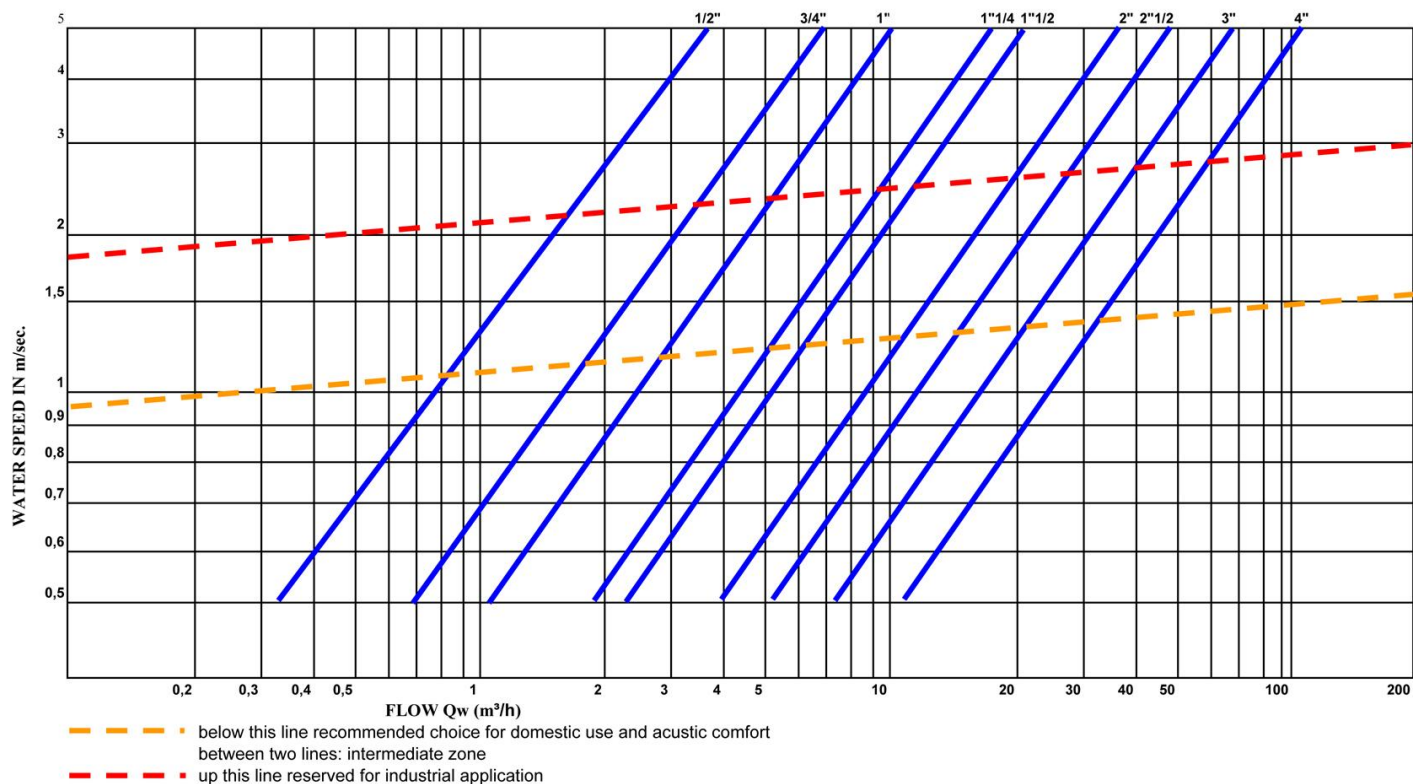

CAVITATION CHART:

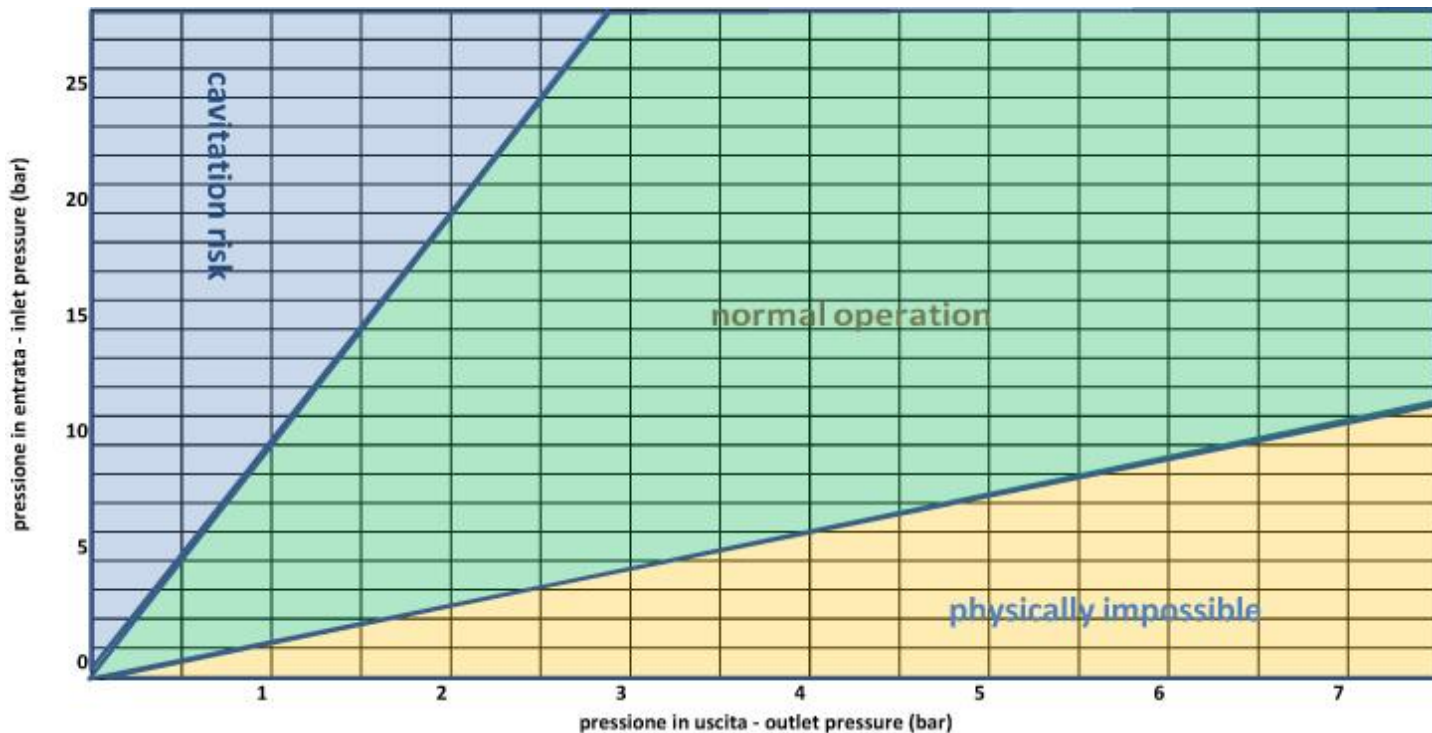

BEST HYDRAULIC DISCHARGE OF PRESSURE REDUCERS EUROBRASS 143

In order to choose the best pressure reducers for any plant, we suggest to follow the indications mentioned in the underexposed table with the best running pressure of the valves Eurobrass 143; the values are exposed both in litres/minute and cbm/hour, and indicate the field of use where you can obtain the best functioning, silence and smaller loss of charge of the valves.

MODEL	SIZE	AVERAGE HYDRAULIC DISCHARGE L/min	AVERAGE HYDRAULIC DISCHARGE Cbm/hour
EUROBRASS 143	3/8"	15 - 30	0,9 - 1,8
EUROBRASS 143	1/2"	20 - 50	1,2 - 3
EUROBRASS 143	3/4"	50 - 75	3 - 4,5
EUROBRASS 143	1"	75 - 95	4,5 - 6
EUROBRASS 143	1" 1/4	95 - 130	6 - 8
EUROBRASS 143	1" 1/2	110 - 140	7 - 8,5
EUROBRASS 143	2"	120 - 160	7,5 - 10
EUROBRASS 143	2" 1/2	140 - 180	8,5 - 11
EUROBRASS 143	3"	160 - 220	10 - 13,2
EUROBRASS 143	4"	200 - 260	12 - 15,6

INSTALLATION OF THE PRESSURE REDUCING VALVE

The pressure reducers EUROBRASS 143 don't get the effects – for their functioning – of the gravity force; therefore they can be installed in the plant in any position:

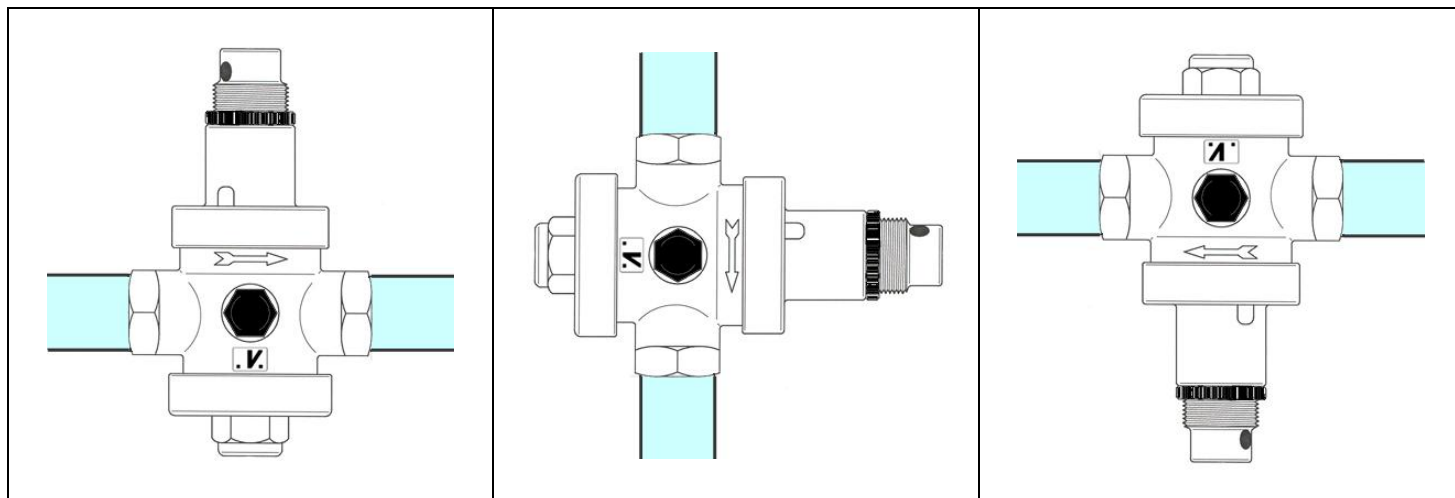

Pressure reducing valves can be damaged by dirty water; therefore we advise to install a self-cleaning filter upstream before the pressure reducer, in order to protect the valve and any other mechanism (thermostatic mixers, taps, etc.).

When there is a device which produce or store hot water or pipes are exposed to sudden changes in temperature, an increase of outlet pressure may occur; this event is due to the raise in pressure that follows the temperature rising: an expansion vessel between downstream the pressure reducing valve will avoid this problem.

We recommend moreover to install a Stopshock valve to prevent water hammer which would damage the inner parts of the pressure reducer and other devices in the waterworks.

Recommended installation of the pressure reducing valve:

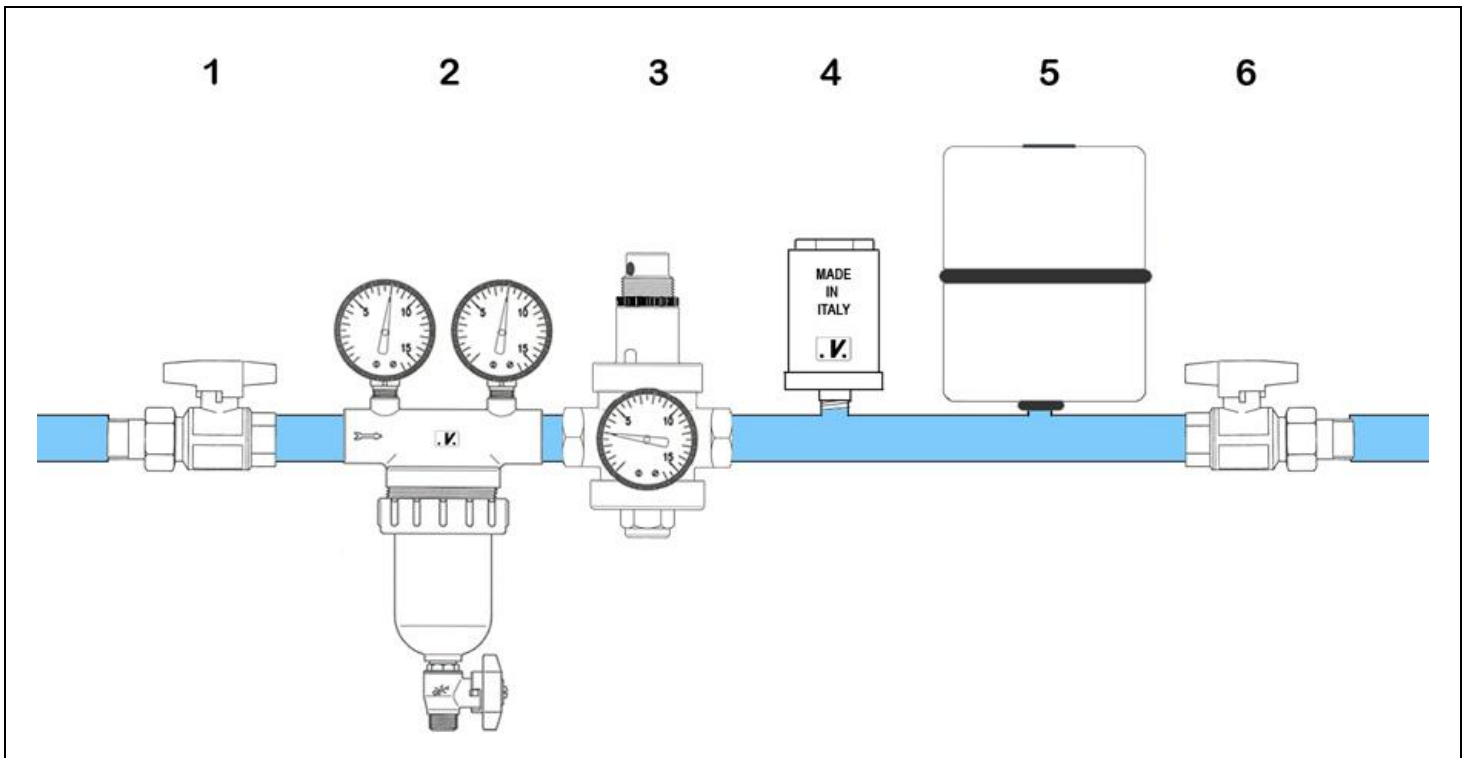

1 – BALL VALVE
2 – NEPTUN SELF-CLEANING FILTER

3 – EUROBRASS PRESSURE REDUCER
4 – STOPSHOCK VALVE

5 – EXPANSION VESSEL
6 – BALL VALVE

HOW TO ADJUST THE PRESSURE

All Malgorani pressure reducers are tested before being packaged; during the proof they are pre-set at the outlet pressure of 3 bars; the model 143. Installation or any change of outlet pressure must be performed by qualified personnel; In order to modify the outlet pressure, once removed the seal, you should only loosen the fixing ring and turn the spring holder as indicated in the pictures sequence. By turning clockwise the pressure increases, while counter-clockwise the pressure decreases. A right setting should be made while the plant outlet is closed.

